

NEUHEITEN 2018

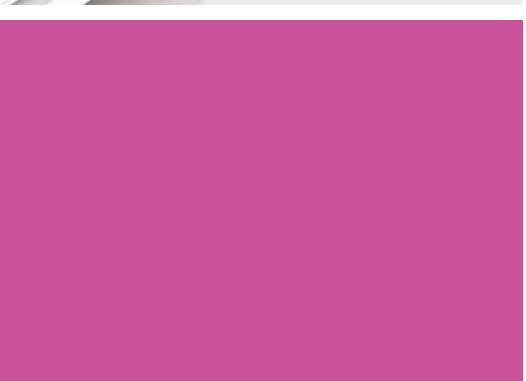



Inhaltsverzeichnis

Bereich	Bezeichnung	Serie	Seite
---------	-------------	-------	-------

MINIATUR

Snap-in IP67	Zweifachverteiler	720	6–7
Bajonett NCC	Flanschdosen mit Rückwandmontage	770	8–9

POWER

HEC	Power Kabel- und Flanschsteckverbinder	696	12–15
HEC	Klappdeckel	696	16–17
HEC	Litzendichtung für Power Flanschsteckverbinder 5-polig	696	18–19
HEC	Schlauchverschraubung	696	20–21

MEDIZINISCHE ANWENDUNGEN

ELC	Easy Locking Kabelstecker und Flanschdose	570	24–25
-----	---	-----	-------

AUTOMATISIERUNGSTECHNIK Sensorik & Aktorik

M8	Kabelstecker und -dose, 5-polig, umspritzt	718	28–29
M8	Kabel- und Flanschsteckverbinder, 12-polig	768 · 718	30–31
M12-A	Food & Beverage nach FDA	763, 765	32–33
M12-A	Flanschstecker, positionierbar und einrastbar	713 · 763	34–35

AUTOMATISIERUNGSTECHNIK Datenübertragung & Spannungsversorgung

M12-X	Kabeldose und Schaltschrankdurchführungen	825 · 876	38–39
M12-K	Kabel- und Flanschsteckverbinder	814	40–41
M12-L	Kabel- und Flanschsteckverbinder	813	42–43

LED-LEUCHTEN

LED	Endkappe mit gedrehtem Gewinde	976	46–47
-----	--------------------------------	-----	-------

MINIATUR STECKVERBINDER



Snap-in IP67

Serie	720
Polzahl	3, 5
Bemessungsstrom	7 A – 5 A (pro Leiterbahn)
Bemessungsspannung	250 V – 125 V
Schutzart	IP67
Kontaktfläche	Au (Gold)



Serie 720 · Zweifachverteiler

- Erweiterung des Produktspektrums der Serie 720
- Zweifachverteiler: Stecker auf zwei Dosen
- 1:1 verdrahtet
- 3- und 5-polig
- IP67
- Lieferbar ab 02/18



Bezeichnung

Zweifachverteiler, Stecker – 2 Dosen

Maßzeichnung

Polzahl

Bestell-Nr.

3	79 9179 000 03
5	79 9180 000 05

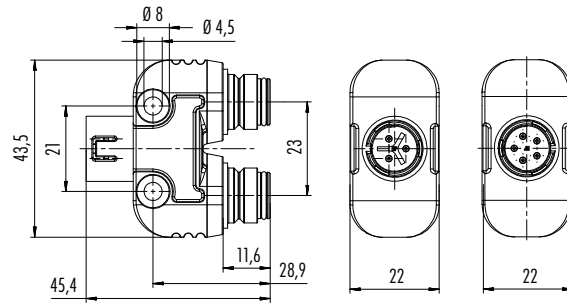

Schaltungen

3 pol

5 pol

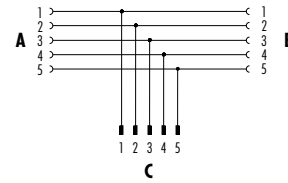
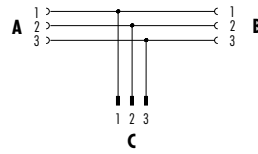

NCC

Serie	770
Polzahl	8
Bemessungsstrom	2 A
Bemessungsspannung	175 V
Schutzart	IP67
Kontaktfläche	Au (Gold)
Anschluss	löten, tauchlöten



Serie 770 NCC · Flanschdosen mit Rückwandmontage

- Erweiterung der Anwendungsmöglichkeiten
- Von vorne zu verschrauben
- IP67 im nicht gesteckten Zustand
- Lieferbar ab 03/18

Bezeichnung	Maßzeichnung	Polzahl	Bestell-Nr.
Flanschdose, von vorne verschraubbar, löten		8	09 0774 180 08

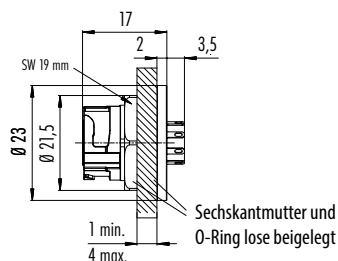

Flanschdose, von vorne verschraubbar, tauchlöten		8	09 0774 190 08
--	--	---	----------------

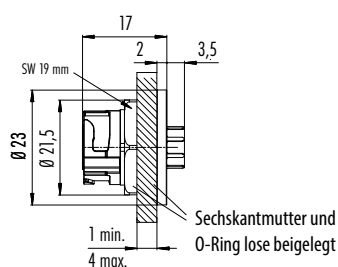

Montageausschnitt

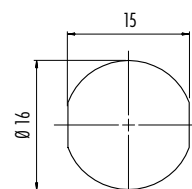



POWER STECKVERBINDER



HEC

Serie	696
Polzahl	4+PE
Kabeldurchlass	7–17 mm
Bemessungsstrom	32 A
Bemessungsspannung	600 V
Schutzart	IP68, IPX9K
Kontaktfläche	Ag (Silber)
Anschluss	crimpen (2,5–6 mm ²)



Serie 696 HEC • Power Kabel- und Flanschsteckverbinder

- Erweiterung des Produktspektrums der Serie 696 HEC
- Leistungsstark 32 A, 600 V bei kleinster Bauweise
- Crimpanschluss 2,5–6 mm² ¹⁾
- UL- Zulassung
- CSA und VDE in Vorbereitung
- Lieferbar ab sofort

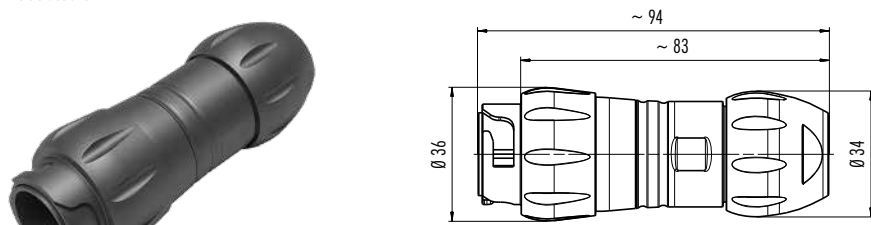

Bezeichnung	Maßzeichnung	Polzahl	Bestell-Nr. ¹⁾
Kabelstecker	 <p>~ 94 ~ 83 Ø 36 Ø 34</p> <p>c RU us VDE in Vorbereitung</p>	4+PE	99 6489 000 05

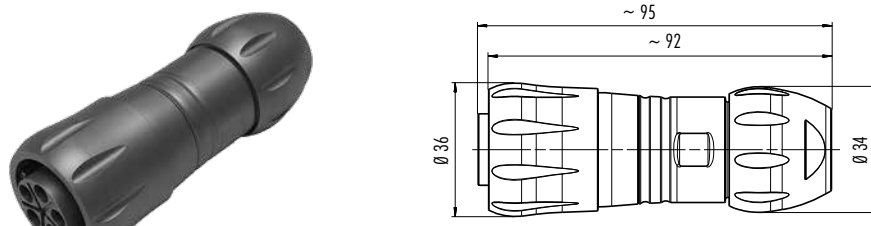
Kabeldose	 <p>~ 95 ~ 92 Ø 36 Ø 34</p> <p>c RU us VDE in Vorbereitung</p>	4+PE	99 6490 000 05
-----------	--	------	----------------

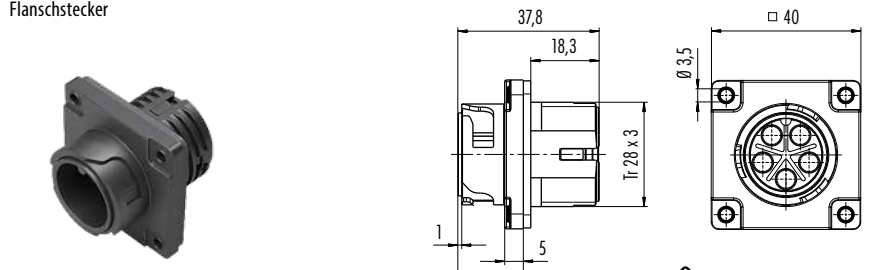
Flanschstecker	 <p>37,8 18,3 □ 40 Ø 3,5 Tr 28 x 3 1 5 17,5</p> <p>c RU us VDE in Vorbereitung</p>	4+PE	09 6491 000 05
----------------	---	------	----------------

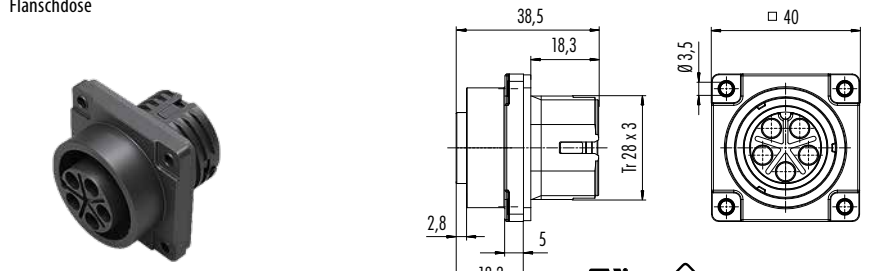
Flanschdose	 <p>38,5 18,3 □ 40 Ø 3,5 Tr 28 x 3 2,8 5 18,2</p> <p>c RU us VDE in Vorbereitung</p>	4+PE	09 6492 000 05
-------------	--	------	----------------



¹⁾ Crimpkontakte müssen separat bestellt werden.

Bezeichnung	Maßzeichnung	Kontakt-Ø	A	B	Anschluss-Ø	Bestell-Nr. ¹⁾
Stiftkontakt, VPE 100 Stück		3,6 mm	2,2	3,3	2,5 mm ²	61 1312 139
			2,8	3,9	4 mm ²	61 1310 139
			3,5	4,6	6 mm ²	61 1285 139



Buchsenkontakt, VPE 100 Stück		3,6 mm	2,2	3,3	2,5 mm ²	61 1313 139
			2,8	3,9	4 mm ²	61 1311 139
			3,5	4,6	6 mm ²	61 1286 139



Bestell-Nr. ¹⁾

Crimpzange für Powerkontakte	66 0005 000
------------------------------	-------------



Lösewerkzeug für Powerkontakte	66 0012 001
--------------------------------	-------------



Polbilder Stifteinsatz (Steckseite)

Polbilder Buchseneinsatz (Steckseite)

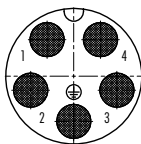

	X	Y
1	-3,82	5,26
2	-6,18	-2,01
3	6,18	-2,01
4	3,82	5,26
PE	0	-6,50

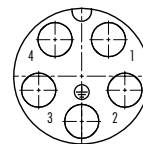

	X	Y
1	3,82	5,26
2	6,18	-2,01
3	-6,18	-2,01
4	-3,82	5,26
PE	0	-6,50

Montageausschnitt

Flanschsteckverbinder

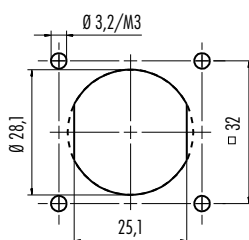

Alternative mit Abflachung



HEC

Serie	696
Polzahl	4+PE, 8 (4 + 3+PE), 12
Bemessungsstrom	32 A – 3A
Bemessungsspannung	600 V – 60 V
Schutzart	IP68, IPX9K
Kontaktoberfläche	Ag (Silber)
Anschluss	crimpen



Serie 696 HEC · Klappdeckel

- Kompakte Bauform: Flanschdose inkl. Klappdeckel
- Einfache und schnelle Montage
- Für alle Polzahlen (4+PE, 4 + 3+PE, 12)
- IP68/IPX9K
- Lieferbar ab 02/18

Bezeichnung

Maßzeichnung

Polzahl

Bestell-Nr.

Flanschdose, Klappdeckel

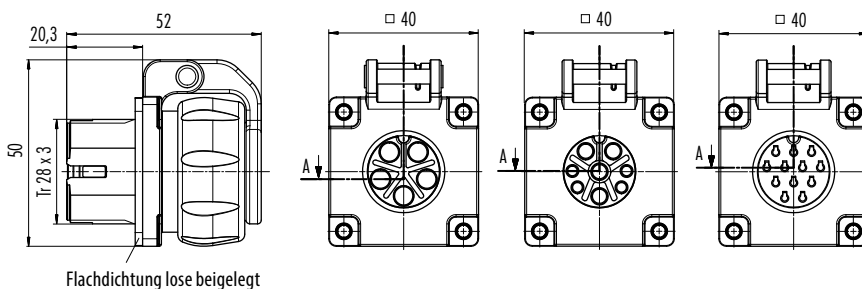

4+PE	09 6492 200 05
4+3+PE	09 6504 200 08
12	09 6520 200 12

Montageausschnitt siehe HEC Power



HEC

Serie	696
Polzahl	4+PE
Schutzart	IP67



Serie 696 · Litzendichtung für HEC Power

- Zubehör für Flanschsteckverbinder der Serie 696 HEC
- Dichtungssatz mit Druckschraube und -ring für Litzendichtung
- „Anschlussseitig“ wirkungsvoller Schutz gegen Feuchtigkeit
- Lieferbar ab 02/18

Bezeichnung	Maßzeichnung	Polzahl	Bestell-Nr.
Dichtungssatz, IP67		4+PE	08 3274 000 000

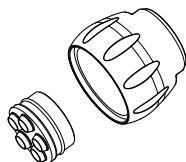

Litzendichtung
Druckschraube



HEC

Serie	696
Polzahl	4+PE, 8 (4 + 3+PE), 12
Bemessungsstrom	32 A – 3A
Bemessungsspannung	600 V – 60 V
Kontaktfläche	Ag (Silber)
Anschluss	crimpen



Serie 696 HEC · Schutzschlauch Verschraubung

- Schützt Kabel und Litzen vor äußeren Einflüssen
- Auch zum Nachrüsten erhältlich
- Lieferbar ab 03/18



Bezeichnung

Maßzeichnung

Polzahl

Bestell-Nr.

Kabelstecker, Schutzschlauch

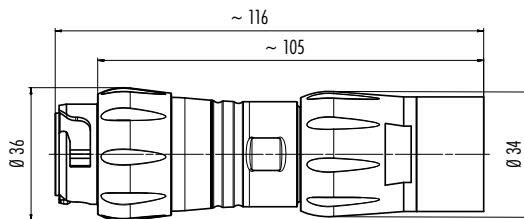

4+PE	99 6489 100 05
4+3+PE	99 6501 100 08
12	99 6517 100 12

Kabeldose, Schutzschlauch

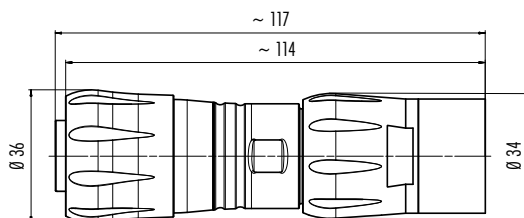

4+PE	99 6490 100 05
4+3+PE	99 6502 100 08
12	99 6518 100 12

Flanschstecker, Schutzschlauch

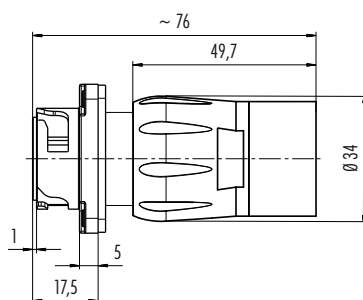

4+PE	09 6491 100 05
4+3+PE	09 6503 100 08
12	09 6519 100 12

Flanschdose, Schutzschlauch

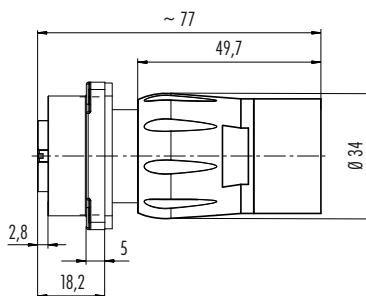

4+PE	09 6492 100 05
4+3+PE	09 6504 100 08
12	09 6520 100 12

Schutzschlauch Verschraubung

Bestell-Nr.

08 0056 000 000

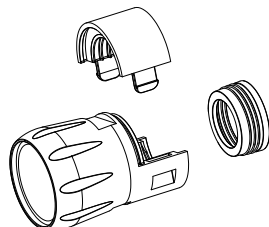

Druckschraube,
Sicherungsclip,
Schlauchdichtung,
sind lose im Beutel

Schutzschlauch, 50 m

08 0071 050 000

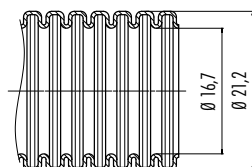

STECKVERBINDER FÜR MEDIZINISCHE ANWENDUNGEN

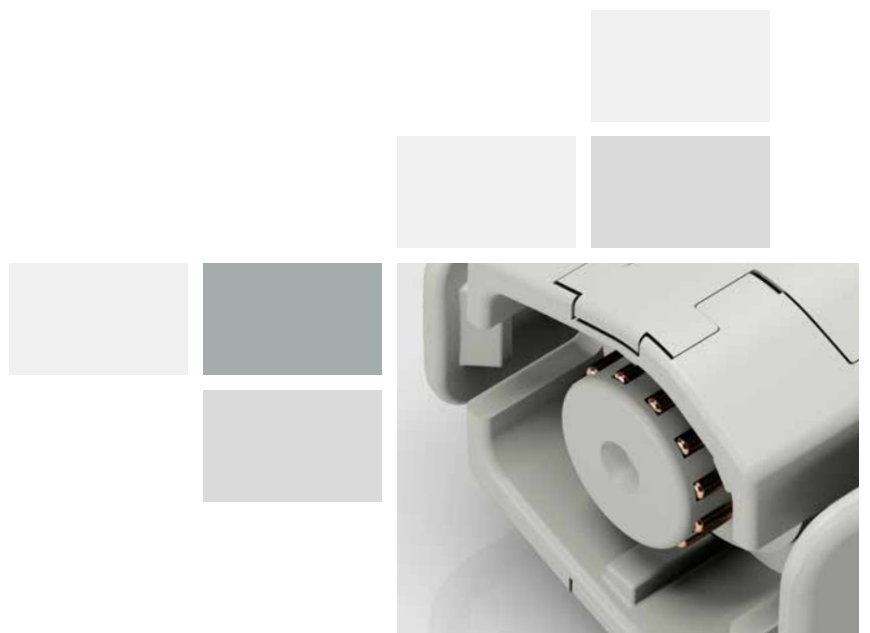

ELC

Serie	570
Polzahl	12
Anschlussquerschnitt	0,25 mm ²
Grenztemperatur	-25°C – +85°C
Bemessungsstrom	2 A
Bemessungsspannung	150 V
Verschmutzungsgrad	2
Schutzart	IP54
Kontaktoberfläche	Au (Gold)
Mechanische Lebensdauer	>5000 Steckzyklen
Material Gehäuse	PA66



Serie 570 ELC · Easy Locking Connector

- Intuitiv zu bedienendes Verriegelungssystem mit Rasthaken
- Steckposition wird eindeutig durch Form des Steckbereichs vorgegeben und verhindert ein Fehlstecken
- Mechanische Beständigkeit mit >5000 Steckzyklen
- Flanschdose gewährleistet Schutz vor Eindringen von Flüssigkeit, Wasserspritzern und Berührung der Kontakte
- Lieferbar ab 04/18

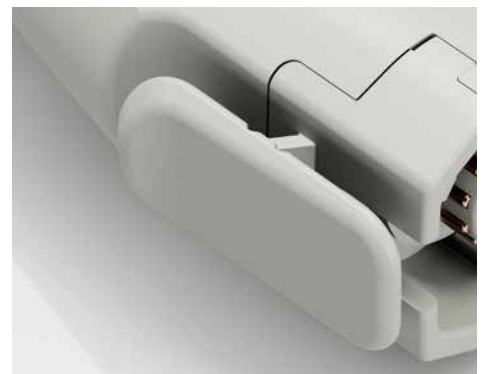
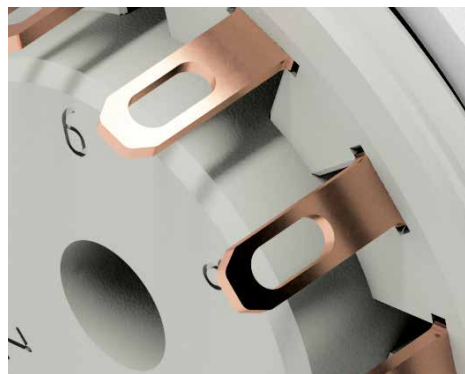

Bezeichnung

Maßzeichnung

Polzahl

Kabeldurchlass 4–6 mm

Kabeldurchlass 6–8 mm

Kabelstecker

12

99 1721 002 12

99 1721 000 12

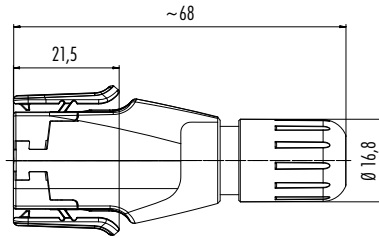

Flanschdose, löten

Polzahl

Bestell-Nr.

Flanschdose, löten

12

09 1724 000 12

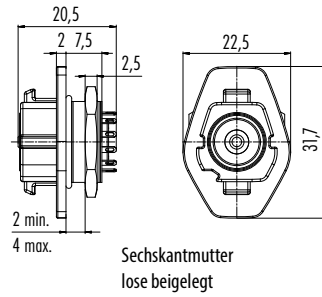

Montageausschnitt

Alternative mit Fläche

Montagewand

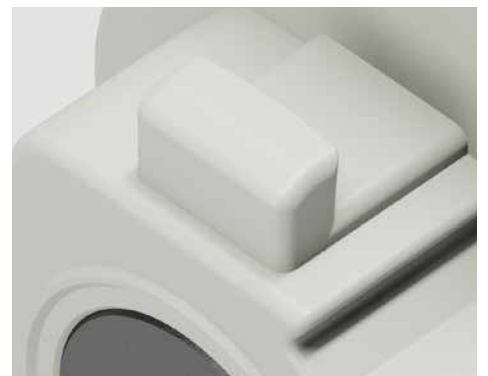
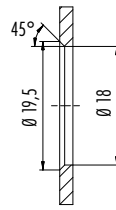
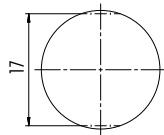

Sensorik & Aktorik



M8

Serie	718
Polzahl	5
Gewinde	M8
Bemessungsstrom	3A
Bemessungsspannung	30 V
Schutzart	IP67
Kontaktfläche	Au (Gold)
Anschluss	PUR-/PVC-Kabel



M8 Kabelsteckverbinder 5-polig umspritzt

- Stecker oder Dose am Kabel angespritzt
- Gerade Ausführung
- Standard-Kabel 2 m und 5 m
- Nach Kundenwunsch konfigurierbar
- Lieferbar ab sofort

Bezeichnung	Maßzeichnung	Polzahl	Kabelmantel	Kabellänge	Bestell-Nr.
Kabelstecker, umspritzt, Schraubversion M8 x 1		5	PVC	2 m	77 3405 0000 20005-0200
				5 m	77 3405 0000 20005-0500
			PUR	2 m	77 3405 0000 50005-0200
				5 m	77 3405 0000 50005-0500



Kabeldose, umspritzt, Schraubversion M8 x 1		5	PVC	2 m	77 3406 0000 20005-0200
				5 m	77 3406 0000 20005-0500
			PUR	2 m	77 3406 0000 50005-0200
				5 m	77 3406 0000 50005-0500





M8

Serie	768 · 718
Polzahl	12
Gewinde	M8
Bemessungsstrom	1A
Bemessungsspannung	30 V
Schutzart	IP67
Kontaktfläche	Au (Gold)
Anschluss	PUR-Kabel/Litzen



M8 Kabel- und Flanschsteckverbinder, 12-polig

- Stecker oder Dose am Kabel angespritzt
- Flanschteile mit Litzen
- Gerade Ausführung
- Standard-Kabel 2 m und 5 m
- Standard-Litzen 200 mm
- Nach Kundenwunsch konfigurierbar
- Lieferbar ab 03/18



Bezeichnung

Maßzeichnung

Polzahl

Kabelmantel

Kabellänge

Bestell-Nr.

Kabelstecker, umspritzt, Schraubverion M8 x 1

12	PUR	2 m	77 3405 0000 50012-0200
		5 m	77 3405 0000 50012-0500

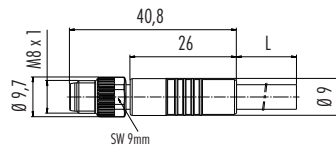

Kabeldose, umspritzt, Schraubverion M8 x 1

12	PUR	2 m	77 3406 0000 50012-0200
		5 m	77 3406 0000 50012-0500

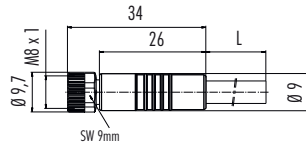

Polzahl **Bestell-Nr.**

Flanschstecker mit Litzen

12	76 6019 0118 00012-0200
----	-------------------------

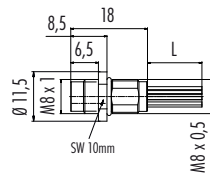

Flanschdose mit Litzen

12	76 6218 1118 00012-0200
----	-------------------------

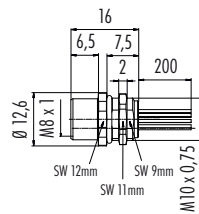

M12-A

Serie	763, 765
Polzahl	3, 4, 5, 8, 12
Kodierung	A
Gewinde	M12 x 1
Bemessungsstrom	4 A, 2 A, 1,5 A
Bemessungsspannung	250 V, 125 V, 60 V
Schutzart	IP69K
Kontaktoberfläche	Au (Gold)
Anschluss	umspritzt
Kabel	TPVHF



M12 A-kodierte Steckverbinder für Food & Beverage • FDA konform

- Für Anwendungen im Bereich Lebensmittel und Pharma sowie der Chemieindustrie
- Zertifizierung nach Ecolab
- Konform nach FDA 21 CFR
- Edelstahlverschraubung (V4A)
- Schutzart IP69K
- Ausführung M12 in allen Polzahlen
- Ansprechendes Design in grau
- Lieferbar ab sofort

Bezeichnung	Maßzeichnung	Polzahl	Kod.	Kabellänge	Bestell-Nr. (FDA konform)		
Kabelstecker, umspritzt		3	A	2 m	77 3729 0000 40403-0200		
				5 m	77 3729 0000 40403-0500		
		4	A	2 m	77 3729 0000 40404-0200		
				5 m	77 3729 0000 40404-0500		
		5	A	2 m	77 3729 0000 40405-0200		
				5 m	77 3729 0000 40405-0500		
		8	A	2 m	77 3729 0000 40908-0200		
				5 m	77 3729 0000 40908-0500		
		12	A	2 m	77 3729 0000 40912-0200		
				5 m	77 3729 0000 40912-0500		
		Winkelstecker, umspritzt		3	A	2 m	77 3727 0000 40403-0200
						5 m	77 3727 0000 40403-0500
4	A			2 m	77 3727 0000 40404-0200		
				5 m	77 3727 0000 40404-0500		
5	A			2 m	77 3727 0000 40405-0200		
				5 m	77 3727 0000 40405-0500		
8	A			2 m	77 3727 0000 40908-0200		
				5 m	77 3727 0000 40908-0500		
12	A			2 m	77 3727 0000 40912-0200		
				5 m	77 3727 0000 40912-0500		

Bezeichnung

Maßzeichnung

Polzahl

Kod.

Kabellänge

Bestell-Nr. (FDA konform)

Kabeldose, umspritzt

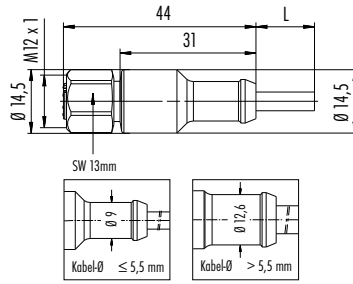

3		2 m	77 3730 0000 40403-0200
		5 m	77 3730 0000 40403-0500
4		2 m	77 3730 0000 40404-0200
		5 m	77 3730 0000 40404-0500
5	A	2 m	77 3730 0000 40405-0200
		5 m	77 3730 0000 40405-0500
8		2 m	77 3730 0000 40908-0200
		5 m	77 3730 0000 40908-0500
12		2 m	77 3730 0000 40912-0200
		5 m	77 3730 0000 40912-0500

Winkeldose, umspritzt

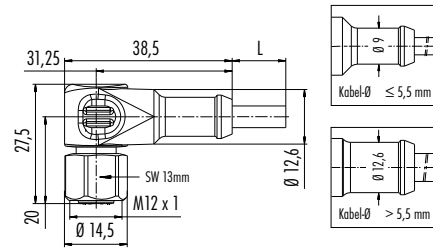

3		2 m	77 3734 0000 40403-0200
		5 m	77 3734 0000 40403-0500
4		2 m	77 3734 0000 40404-0200
		5 m	77 3734 0000 40404-0500
5	A	2 m	77 3734 0000 40405-0200
		5 m	77 3734 0000 40405-0500
8		2 m	77 3734 0000 40908-0200
		5 m	77 3734 0000 40908-0500
12		2 m	77 3734 0000 40912-0200
		5 m	77 3734 0000 40912-0500

Verbindungsleitung, Kabelstecker M12 x 1 – Kabeldose M12 x 1

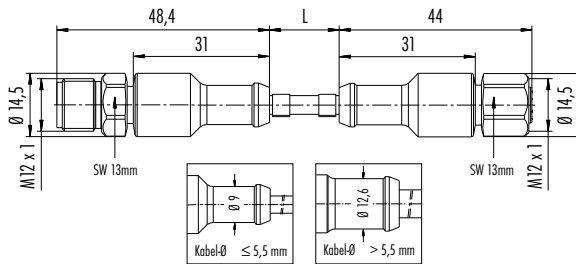

3		2 m	77 3730 3729 40403-0200
		5 m	77 3730 3729 40403-0500
4		2 m	77 3730 3729 40404-0200
		5 m	77 3730 3729 40404-0500
5	A	2 m	77 3730 3729 40405-0200
		5 m	77 3730 3729 40405-0500
8		2 m	77 3730 3729 40908-0200
		5 m	77 3730 3729 40908-0500
12		2 m	77 3730 3729 40912-0200
		5 m	77 3730 3729 40912-0500

Verbindungsleitung, Kabelstecker M12 x 1 – Winkeldose M12 x 1

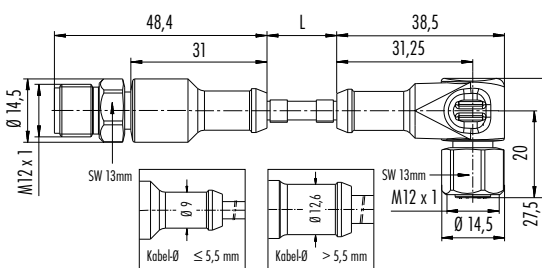

3		2 m	77 3734 3729 40403-0200
		5 m	77 3734 3729 40403-0500
4		2 m	77 3734 3729 40404-0200
		5 m	77 3734 3729 40404-0500
5	A	2 m	77 3734 3729 40405-0200
		5 m	77 3734 3729 40405-0500
8		2 m	77 3734 3729 40908-0200
		5 m	77 3734 3729 40908-0500
12		2 m	77 3734 3729 40912-0200
		5 m	77 3734 3729 40912-0500

Verbindungsleitung, Winkelstecker M12 x 1 – Kabeldose M12 x 1

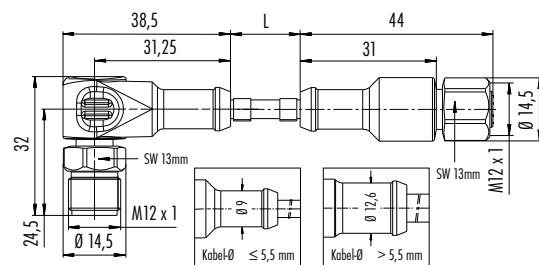

3		2 m	77 3730 3727 40403-0200
		5 m	77 3730 3727 40403-0500
4		2 m	77 3730 3727 40404-0200
		5 m	77 3730 3727 40404-0500
5	A	2 m	77 3730 3727 40405-0200
		5 m	77 3730 3727 40405-0500
8		2 m	77 3730 3727 40908-0200
		5 m	77 3730 3727 40908-0500
12		2 m	77 3730 3727 40912-0200
		5 m	77 3730 3727 40912-0500

Verbindungsleitung, Winkelstecker M12 x 1 – Winkeldose M12 x 1

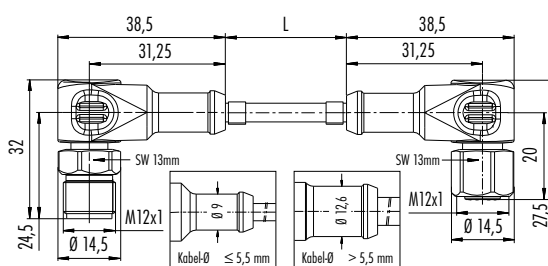

3		2 m	77 3734 3727 40403-0200
		5 m	77 3734 3727 40403-0500
4		2 m	77 3734 3727 40404-0200
		5 m	77 3734 3727 40404-0500
5	A	2 m	77 3734 3727 40405-0200
		5 m	77 3734 3727 40405-0500
8		2 m	77 3734 3727 40908-0200
		5 m	77 3734 3727 40908-0500
12		2 m	77 3734 3727 40912-0200
		5 m	77 3734 3727 40912-0500

M12-A

Serie	763
Polzahl	4, 5, 8
Kodierung	A </td
Gewinde	M12
Bemessungsstrom	4 A (3 A UL), 1,5 A (2A UL)
Bemessungsspannung	250 V, 60 V, 30 V
Schutzart	IP68 im gesteckten Zustand
Kontaktoberfläche	Au (Gold)
Anschluss	Litzen AWG24/7



M12 Flanschstecker mit positionierbarer, einrastbarer Kodierung

- Zweiteiliger Flanschstecker bestehend aus Gehäuse und Kontaktträger
- Getrennte Verarbeitung von Kontaktträgern und Gehäusen möglich
- Vorkonfektionierte Litzen AWG24/7 in variablen Längen erlauben einfache Weiterverarbeitung
- Die Drehbarkeit der Kodierung im 45° Raster ermöglicht verschiedene Kabelabgangsrichtungen gewinkelter Steckverbinder
- Lieferbar ab 11/17



Bezeichnung

Flanschstecker, Vierkantflansch, positionierbarer, einrastbar

Maßzeichnung

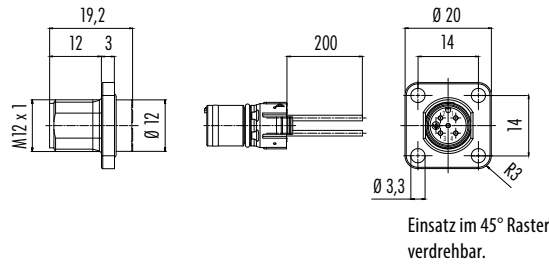

Polzahl

Kodierung

Bestell-Nr.

4		99 3433 100 04
5	A	99 3443 100 05
8		99 3483 100 08



Montageanleitung

Montage:

1. Kontakteinsatz in gewünschter Einbaulage in das Gehäuse einführen, bis er sicher einrastet.

Demontage:

1. Rasthebel drücken.
2. Gleichzeitig mit einem geeigneten Gegenstand, von der Steckseite aus, den Kontaktkörper herausdrücken, ohne die Kontakte zu beschädigen.

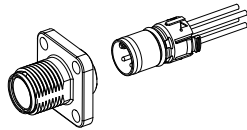

Hinweis:

Bei der Demontage bitte nicht an den Adern ziehen!

Montageausschnitt

Flanschsteckverbinder Vierkantflansch

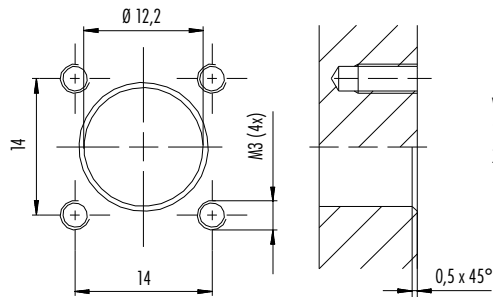

Voraussetzungen für Schutzart IP67:

1. Verwendung von Dichtung, Best.-Nr. 16 0959 000
2. Gewinde M3 (4x) als Gewindesacklöcher oder Schraubenköpfe abgedichtet



Datenübertragung & Spannungsversorgung



M12-X

Serie	825
Polzahl	8
Kodierung	X
Gewinde	M12 x 1
Bemessungsstrom	0,5 A
Bemessungsspannung	50 V AC, 60 V DC
Schutzart	M12-X IP67, RJ45 IP20
Kontaktoberfläche	Au (Gold)
Anschluss	M12-X, RJ45



M12 X-kodierte Kabeldose auf RJ45 Adapter und Schaltschrankdurchführungen

- Erweiterung des Produktportfolios M12-X
- Datenübertragung 4-paarig bis 10 Gbit/s
- Nach DIN IEC 61076-2-109
- Schaltschrankdurchführung/Adapter M12-X Dose auf RJ45
- Gerade und gewinkelt
- Lieferbar ab 03/18



Bezeichnung	Maßzeichnung	Polzahl	Kabeldurchlass	Bestell-Nr.
Kabeldose, Schneidklemmanschluss, schirmbar		8	5,5–9 mm	99 3788 810 08

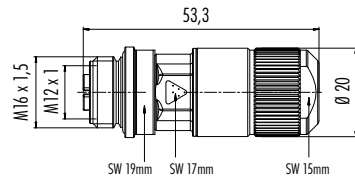

Polzahl	Bestell-Nr.
8	09 5287 00 08

Adapter, Schaltschrankdurchführung, M12-X Dose – RJ45 gerade

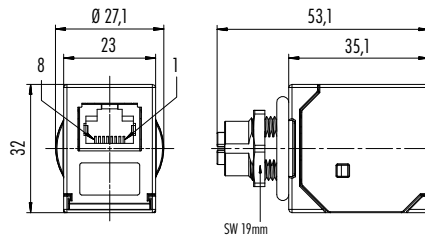

Polzahl	Bestell-Nr.
8	09 5287 00 08

Adapter, Schaltschrankdurchführung, M12-X Dose – RJ45 gewinkelt

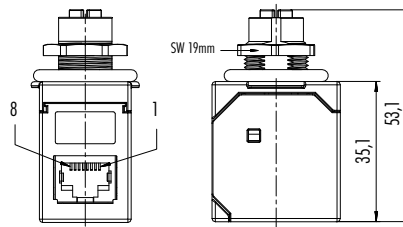

Polzahl	Bestell-Nr.
8	09 5288 00 08

Montageausschnitt

Kabeldose

Verwendung im Flansch mit Mutter M16 x 1,5

Verwendung im Flansch mit geschnittenem Gewinde

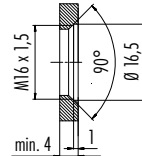
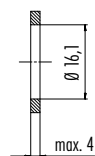

Adapter, Schaltschrankdurchführung

mit Verdrehschutz

ohne Verdrehschutz

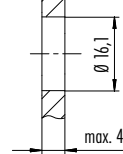
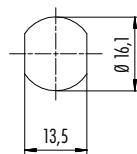

M12-K

Serie	814
Polzahl	4+PE
Kodierung	K
Gewinde	M12 x 1
Bemessungsstrom	12 A
Bemessungsspannung	630 V AC
Schutzart	IP67/IP68 im gesteckten Zustand
Kontaktoberfläche	Au (Gold)
Anschluss	Litzen AWG 16
Norm	DIN IEC 61076-2-111



M12 K-kodierte, konfektionierbare Power-Kabel- & Flanschsteckverbinder

- Vorkonfektionierte Flanschstecker und -dose zur Spannungsversorgung
- K-Kodierung für AC Spannungsversorgung
- UL PVC Litzen AWG 16 Style 1007/1569
- Standardlitzenlänge 200 mm. Längenvarianten auf Anfrage
- UL- und VDE-Zulassung sind in Vorbereitung
- Lieferbar ab 04/18



Bezeichnung	Maßzeichnung	Polzahl	Kod.	Kabeldurchlass	Bestell-Nr.
-------------	--------------	---------	------	----------------	-------------

Kabelstecker, Power, K-Kodierung, Schraubklemmanschluss

4+PE K 8-13 mm 99 0699 29 05

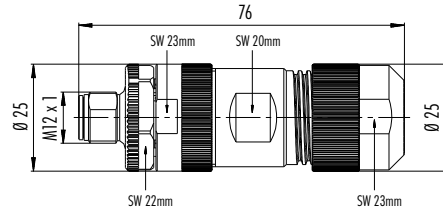

Kabeldose, Power, K-Kodierung, Schraubklemmanschluss

4+PE K 8-13 mm 99 0700 29 05

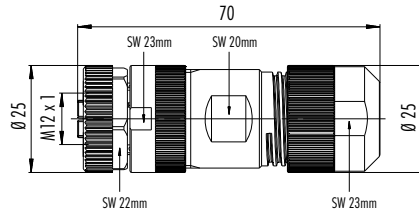

Flanschstecker mit Litzen, Power, K-Kodierung

Polzahl Kod. Bestell-Nr.
4+PE K 09 0701 700 05

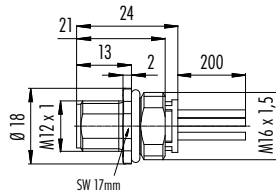

Flanschdose mit Litzen, Power, K-Kodierung

4+PE K 09 0702 700 05

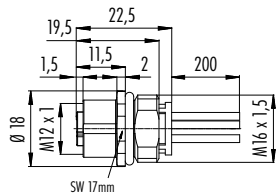

Montageausschnitt

Flanschsteckverbinder

Mit Fläche als Verdrehschutz

Mit Durchgangsbohrung

Mit Gewinde, einschraubbar

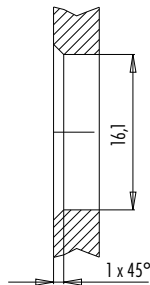
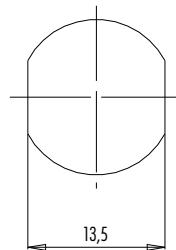

Alternativ

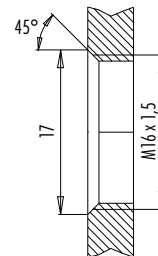

M12-L

Serie	813
Polzahl	4+FE
Kodierung	L
Gewinde	M12 x 1
Bemessungsstrom	16 A
Bemessungsspannung	63 V DC
Schutzart	IP67/IP68 im gesteckten Zustand
Kontaktoberfläche	Au (Gold)
Anschluss	Litzen AWG 16
Norm	DIN IEC 61076-2-111



M12 L-kodierte, konfektionierbare Power-Kabel- & Flanschsteckverbinder

- Vorkonfektionierte Flanschstecker und -dose zur Spannungsversorgung
- L-Kodierung für DC Spannungsversorgung Profinet-konform
- UL PVC Litzen AWG 16 Style 1007/1569
- Standardlitzenlänge 200 mm. Längenvarianten auf Anfrage
- UL- und VDE-Zulassung sind in Vorbereitung
- Lieferbar ab 11/17



Bezeichnung	Maßzeichnung	Polzahl	Kod.	Kabeldurchlass	Bestell-Nr.
-------------	--------------	---------	------	----------------	-------------

Kabelstecker, Power, L-Kodierung, Schraubklemmanschluss

4+FE L 8-13 mm 99 0639 29 05

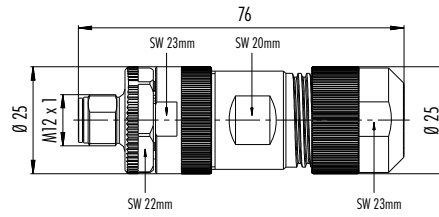

Kabeldose, Power, L-Kodierung, Schraubklemmanschluss

4+FE L 8-13 mm 99 0640 29 05

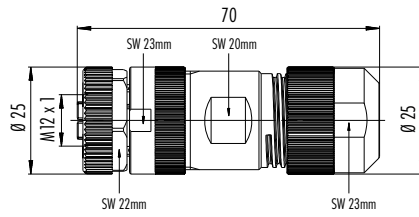

Flanschstecker mit Litzen, Power, L-Kodierung

Polzahl Kod. Bestell-Nr.
4+FE L 09 0641 700 05

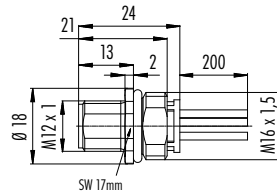

Flanschdose mit Litzen, Power, L-Kodierung

4+FE L 09 0642 700 05

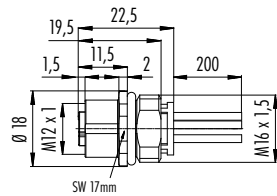

Montageausschnitt

Flanschsteckverbinder

Mit Fläche als Verdrehschutz

Mit Durchgangsbohrung

Mit Gewinde, einschraubbar

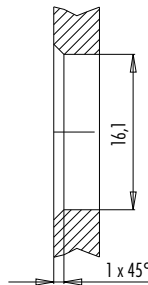
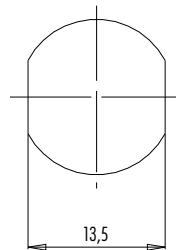

Alternativ

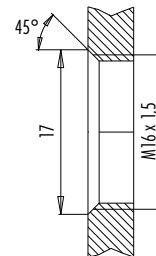

LED LEUCHTEN



LED

Serie	976
Polzahl	4
Gewinde	M12 x 1
Länge	250 mm, 358 mm, 412 mm
Leistung	4,8 W, 7,68 W, 9,12 W
Bemessungsspannung	24 V
Schutzart	IP67/IP68/IP69K
Lichtfarbe	4000 K
Lebensdauer	50.000 h



binder LED – Endkappe mit gedrehtem Gewinde

- Schutzart IP67, IP68 und IP69K
- Drei Leuchtenlängen
- Edelstahl-Ausführung
- M12 Anschluss-System
- Runde, kompakte Bauform
- Lieferbar ab sofort

Bezeichnung

LED-Leuchte, Endkappe Edelstahl

Maßzeichnung

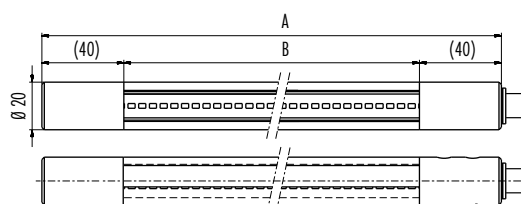

Polzahl

4

Material Endkappe

Edelstahl (V2A)

Bestell-Nr.

28 1300 000 04

28 1301 000 04

28 1302 000 04





**Franz Binder GmbH & Co.
Elektrische Bauelemente KG**

Rötelstraße 27
74172 Neckarsulm
Deutschland

Tel. +49 7132 325-0
Fax +49 7132 325-190

vk@binder-connector.de
www.binder-connector.de